

Data Sheet



Article number: 20332345

Description: E+G Handwheel
GN 555-300-K30-D

Measures

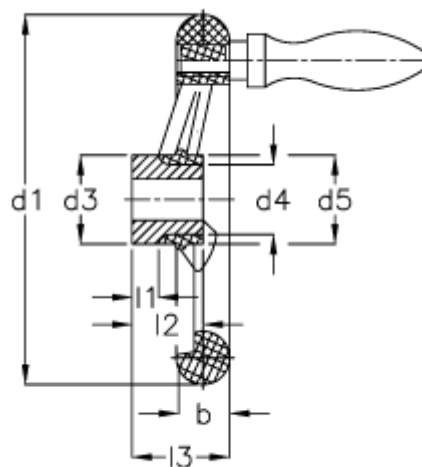
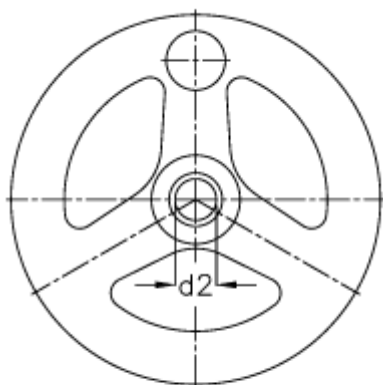

b	= 32	l1 -0.5	= 2
d1	= 300	l2 -0.5	= 40
d2 H7	= 30	l3	= 62
d2 H7	= 26	Number of spokes	= 3
d3	= 58		
d4	= 47		
d5	= 70		
Handle	= 32		